



愛高實業(香港)有限公司

HICO INDUSTRIAL (HK) LIMITED

PRODUCT SPECIFICATION

10-LAP SPORT WATCH

Product Code:	HCS-T005-0
Version:	1.0
Date:	September 28, 2001

Hong Kong 香港

22nd Floor, Delta House, 3 On Yiu Street, Siu Lek Yuen, Shatin, N. T., Hong Kong
香港新界沙田小瀝源安耀街三號匯達大廈二十二樓
Tel: 26486862 Fax: 26373691 Email: enquiry@hico.com.hk

Shenzhen 深圳

Rm. 1605, 16/F., Times Plaza, 1 Prince Road, Shekou, Shenzhen, China
深圳蛇口太子路一號新時代廣場十六樓一六零五室
Tel: (0755)6812638 Fax: (0755)6817308 Email: sales@sz.hico.com.hk

Shanghai 上海

Level 21, HSBC Tower, 101 Yin Cheng East Road, Pudong, Shanghai, China 200120
上海市浦東新區銀城東路 101 號匯豐大廈二十一樓, 郵編: 200120
Tel: (021)28903020 Fax: (021)28903022 Email: sales@sh.hico.com.hk

Room 833, No. 8 Huajing Road, Waigaoqiao Free Trade Zone, Pudong, Shanghai, China 200131
上海市浦東外高橋保稅區華京路八號八三三室, 郵編: 200131
Tel: (021)50462088 Fax: (021)50460960



愛高實業(香港)有限公司 HICO INDUSTRIAL (HK) LIMITED

22/F., DELTA HOUSE, 3 ON YIU STREET, SIU LEK YUEN, SHATIN, N.T., HONG KONG.

TEL: (852) 2648 6862 FAX: (852) 2637 3691 URL: <http://www.hico.com.hk> EMAIL: enquiry@hico.com.hk

香港新界沙田小瀝源安耀街三號匯達大廈二十二樓

10-Lap Sport Watch (HCS-T005-0)

FEATURES

- LSI Used
 - SANYO LC573706A
- Real Time Clock
 - Hour, Minute and Second display
 - 12 or 24 hour display format selectable by key option
 - Hourly time signal selectable by key option
- Dual Time Clock
 - Hour, Minute and Second display
 - User adjustable Hour and Minute with Second synchronized with Real Time Clock
- Daily Alarm
- Schedule Alarm
 - User adjustable alarm with Month, Day, Day of Week, Hour and Minute
- Auto Calendar
 - Month, Day and Day of Week display
 - Auto adjustment for leap year ranging from 2000 to 2079
- Pacer Beat
 - Adjustable beat rate from 65 to 180 beats per minute with settable resolution 5 beats per step
- Chronograph
 - Count up to 9 hours 59 minutes 59.99 seconds with resolution up to 1/100 second
 - Memory for 10 lap time
- Count Down Timer
 - User adjustable preset time ranging from 1 minute up to 23 hours 59 minutes with resolution 1 minute per step
- Beep tone alert for mode change
- Output signal for EL backlight control
- Operate with 3V Lithium battery



愛高實業(香港)有限公司

HICO INDUSTRIAL (HK) LIMITED

22/F., DELTA HOUSE, 3 ON YIU STREET, SIU LEK YUEN, SHATIN, N.T., HONG KONG.

TEL: (852) 2648 6862 FAX: (852) 2637 3691 URL: <http://www.hico.com.hk> EMAIL: enquiry@hico.com.hk

香港新界沙田小瀝源安耀街三號匯達大廈二十二樓

10-Lap Sport Watch (HCS-T005-0)

LCD PATTERN

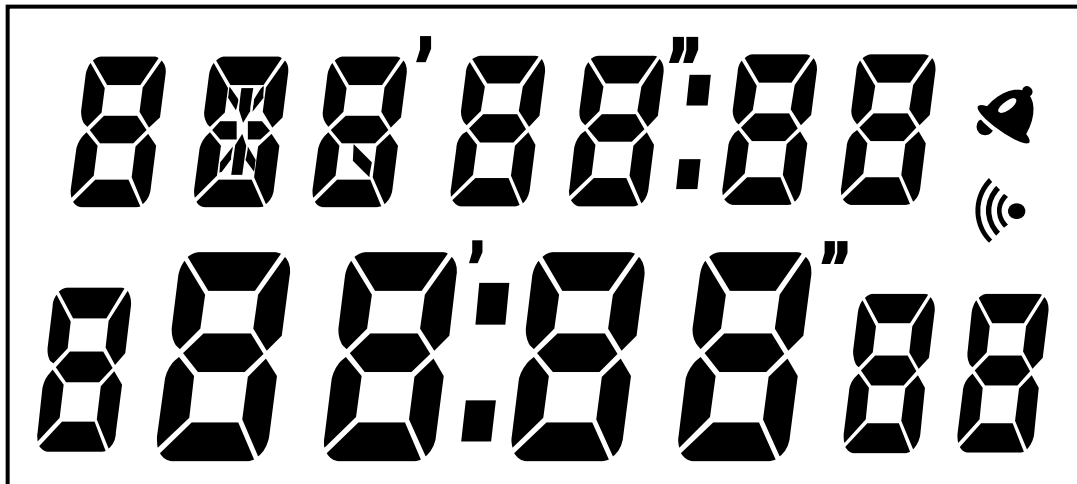

- Operating Voltage: 4.5V
- Duty Cycle: 1/3
- Bias: 1/3
- Viewing Direction: 6H
- Connection: Top and Bottom



愛高實業(香港)有限公司
HICO INDUSTRIAL (HK) LIMITED

22/F., DELTA HOUSE, 3 ON YIU STREET, SIU LEK YUEN, SHATIN, N.T., HONG KONG.

TEL: (852) 2648 6862 FAX: (852) 2637 3691 URL: <http://www.hico.com.hk> EMAIL: enquiry@hico.com.hk

香港新界沙田小瀝源安耀街三號匯達大廈二十二樓

10-Lap Sport Watch (HCS-T005-0)

KEY FUNCTIONS

Keys	Functions
[MODE]	<ul style="list-style-type: none">▪ Change to next operating mode if press and release within 2 seconds▪ Change to setting mode if press and hold for more than 2 seconds
[ST/STP]	<ul style="list-style-type: none">▪ Toggle 12/24-hour display format▪ Activate alarm sound test▪ Select digits to adjust▪ Start/Stop Chronograph, Timer
[LAP/RESET]	<ul style="list-style-type: none">▪ Enable/disable hourly time signal▪ Enable/disable alarm sound▪ Adjust selected digits▪ Start Pacer Beat▪ Activate/Search LAP Time in Chronograph▪ Reset Lap and Accumulated time in Chronograph▪ Reload preset timer value for counting
[LIGHT]	<ul style="list-style-type: none">▪ Press to turn on EL Backlight (high active) for 3 seconds



愛高實業(香港)有限公司 HICO INDUSTRIAL (HK) LIMITED

22/F., DELTA HOUSE, 3 ON YIU STREET, SIU LEK YUEN, SHATIN, N.T., HONG KONG.

TEL: (852) 2648 6862 FAX: (852) 2637 3691 URL: <http://www.hico.com.hk> EMAIL: enquiry@hico.com.hk

香港新界沙田小瀝源安耀街三號匯達大廈二十二樓

10-Lap Sport Watch (HCS-T005-0)

OPERATION FLOWCHART

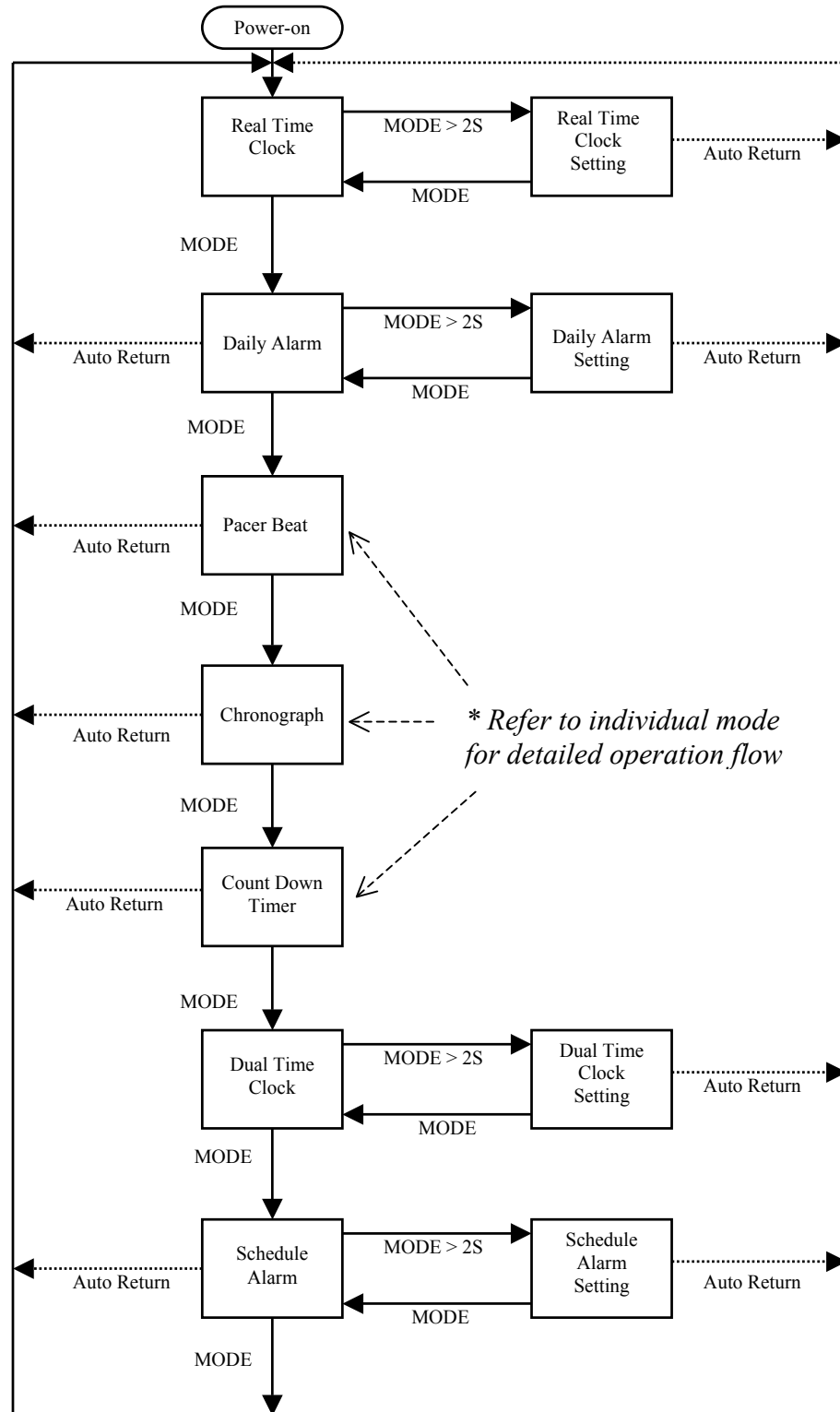



愛高實業(香港)有限公司 HICO INDUSTRIAL (HK) LIMITED

22/F., DELTA HOUSE, 3 ON YIU STREET, SIU LEK YUEN, SHATIN, N.T., HONG KONG.

TEL: (852) 2648 6862 FAX: (852) 2637 3691 URL: <http://www.hico.com.hk> EMAIL: enquiry@hico.com.hk

香港新界沙田小瀝源安耀街三號匯達大廈二十二樓

10-Lap Sport Watch (HCS-T005-0)

OPERATIONAL DESCRIPTIONS

1. Power-up

- All LCD segments will be turned on for 3 seconds
- Default setting:
 - Real Time Clock
 - 12:00:00 AM
 - 2000-1-1 Saturday
 - Hourly time signal disabled
 - 12-hour display format
 - Daily Alarm
 - 12:00 AM
 - Alarm sound disabled
 - Schedule Alarm
 - 12:00 AM
 - Alarm sound disabled
 - Pacer Beat
 - 65 beats per minute
 - Count Down Timer
 - 0:00
 - Stopped
 - Dual Time Clock
 - 12:00 AM

2. Software Reset

- Press and hold [MODE], [ST/SP] and [LAP/RESET] simultaneously will activate software reset. System will perform all initialization same as Power-up.

3. Auto Return

- Real Time Clock display will be resumed if no key operation for 1 minute in any mode except the following:
 - Pacer Beat mode with pacer start running
 - Chronograph start counting
 - Count Down Timer start counting down
 - Dual Time Clock

4. Auto Advance

- In any setting mode, press and release [LAP/RESET] within 2 seconds will increase the selected digit by 1.
- If [LAP/RESET] is pressed and hold for more than 2 seconds, Auto Advance function will be activated with the selected digit increased in a rate of 5 steps per second until [LAP/RESET] is released.



愛高實業(香港)有限公司
HICO INDUSTRIAL (HK) LIMITED

22/F., DELTA HOUSE, 3 ON YIU STREET, SIU LEK YUEN, SHATIN, N.T., HONG KONG.
TEL: (852) 2648 6862 FAX: (852) 2637 3691 URL: <http://www.hico.com.hk> EMAIL: enquiry@hico.com.hk
香港新界沙田小瀝源安耀街三號匯達大廈二十二樓

10-Lap Sport Watch (HCS-T005-0)

5. Real Time Clock

- 12-hour Display format:

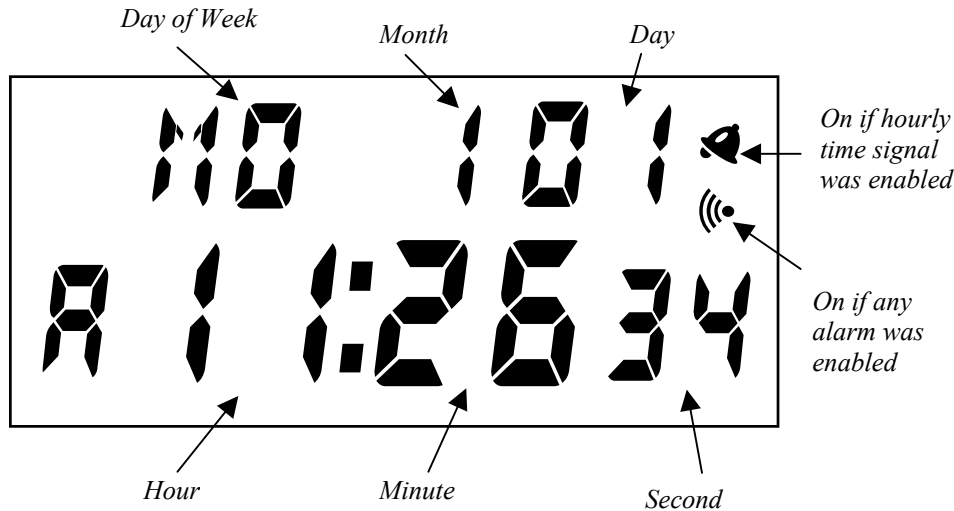

- 24-hour Display format:

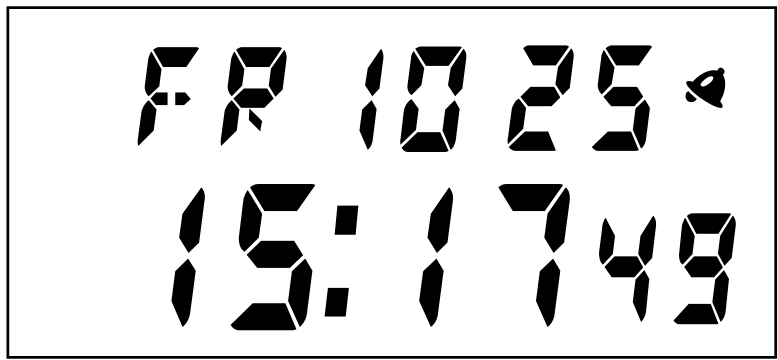

- Press [ST/STP] to toggle between 12/24-hour display format.
- Press [LAP/RESET] to enable/disable hourly time signal. If enabled, “Beep-Beep” sound will be output from buzzer every time Hour is updated.
- Press and release [MODE] within 2 seconds will change to Daily Alarm.
- Press and hold [MODE] for more than 2 seconds will change to Real Time Clock Setting.



愛高實業(香港)有限公司
HICO INDUSTRIAL (HK) LIMITED

22/F., DELTA HOUSE, 3 ON YIU STREET, SIU LEK YUEN, SHATIN, N.T., HONG KONG.

TEL: (852) 2648 6862 FAX: (852) 2637 3691 URL: <http://www.hico.com.hk> EMAIL: enquiry@hico.com.hk

香港新界沙田小瀝源安耀街三號匯達大廈二十二樓

10-Lap Sport Watch (HCS-T005-0)

6. Real Time Clock Setting

- Display format

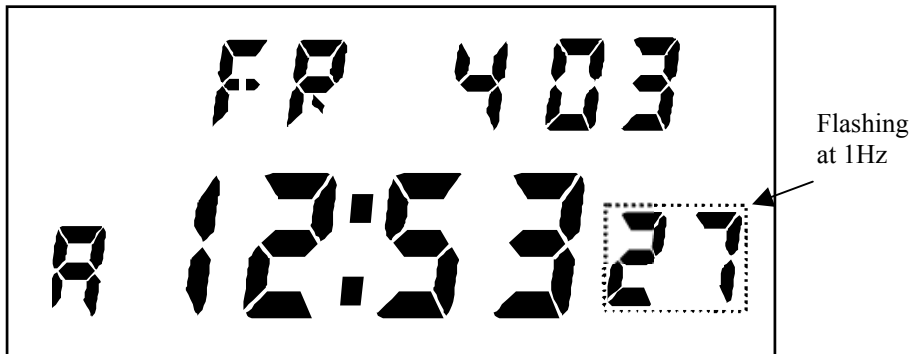

- Display format when Year is shown

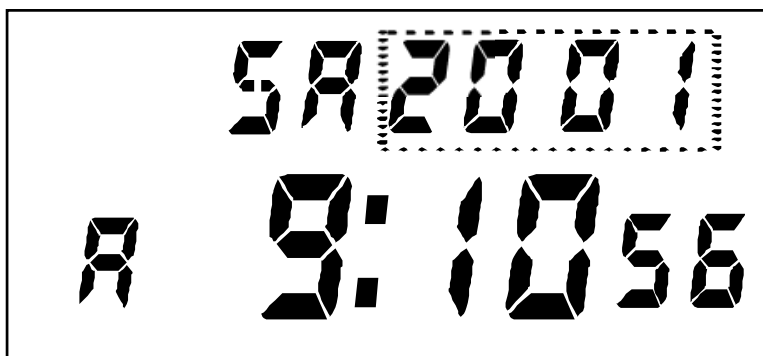

- Press [ST/STP] to select the desired digits for adjustment. Selected digits will be flashed at a rate of 1Hz (i.e. Turn on for 0.5 seconds and then turn off for 0.5 seconds). Digits will be selected in the following sequence:

Seconds -> Minutes -> Hour -> Month -> Day -> Day of Week -> Year -> Seconds

- Press and release [LAP/RESET] within 2 seconds to increase the selected digits by 1.
- Press and hold [LAP/RESET] for more than 2 seconds will activate Auto Advance function.
- When adjusting the Second digits:
 - If Second < 30, Second = 0
 - If Second >=30, Second = 0 with Minute + 1. All subsequent digits will be altered accordingly.



愛高實業(香港)有限公司
HICO INDUSTRIAL (HK) LIMITED

22/F., DELTA HOUSE, 3 ON YIU STREET, SIU LEK YUEN, SHATIN, N.T., HONG KONG.
 TEL: (852) 2648 6862 FAX: (852) 2637 3691 URL: <http://www.hico.com.hk> EMAIL: enquiry@hico.com.hk
 香港新界沙田小瀝源安耀街三號匯達大廈二十二樓

10-Lap Sport Watch (HCS-T005-0)

- Adjustable range for the digits:
 - Minute: 0 to 59
 - Hour: A 12 to P 11 (for 12-hour display)
0 to 23 (for 24-hour display)
 - Month: 1 to 12
 - Day: 1 to 31 (for Month = 1, 3, 5, 7, 8, 10, 12)
1 to 30 (for Month = 4, 6, 9, 11)
1 to 29 (for Month = 2)
 - Day of Week: MO->TU->WE->TH->FR->SA->SU
 - Year: 2000 to 2079
- Press [MODE] once will exit setting and return to Real Time Clock.
- When exiting from setting, the validity of the Date will be checked. If invalid Date is found, the Day will be adjusted automatically to the last day of the selected Month. For example: Month = 4 and Day = 31, when exit, Day will change to 30.

7. Daily Alarm

- Display format:

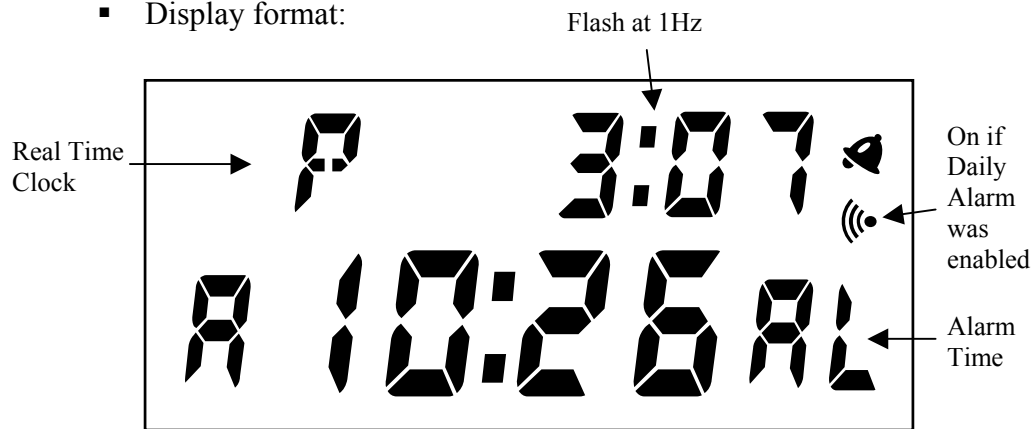

- Display format (24-hour display):

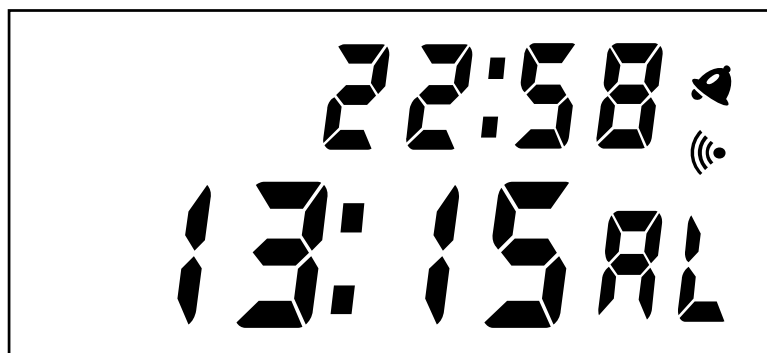



愛高實業(香港)有限公司 HICO INDUSTRIAL (HK) LIMITED

22/F., DELTA HOUSE, 3 ON YIU STREET, SIU LEK YUEN, SHATIN, N.T., HONG KONG.
TEL: (852) 2648 6862 FAX: (852) 2637 3691 URL: <http://www.hico.com.hk> EMAIL: enquiry@hico.com.hk
香港新界沙田小瀝源安耀街三號匯達大廈二十二樓

10-Lap Sport Watch (HCS-T005-0)

- Press and hold [ST/STP] to activate alarm sound test. Alarm sound can be heard from the buzzer until [ST/STP] is released.
- Press [LAP/RESET] to enable/disable Daily Alarm.
 - If enabled, alarm sound can be heard from the buzzer if alarm time is reached.
 - The sound will last for 20 seconds.
 - The sound can be stopped at any time with any key pressed.
 - No alarm sound will be heard in both Real Time Clock Setting and Daily Alarm Setting.
- Press and release [MODE] within 2 seconds to change to Pacer Beat.
- Press and hold [MODE] for more than 2 seconds to activate Daily Alarm Setting.

8. Daily Alarm Setting

- Display format:

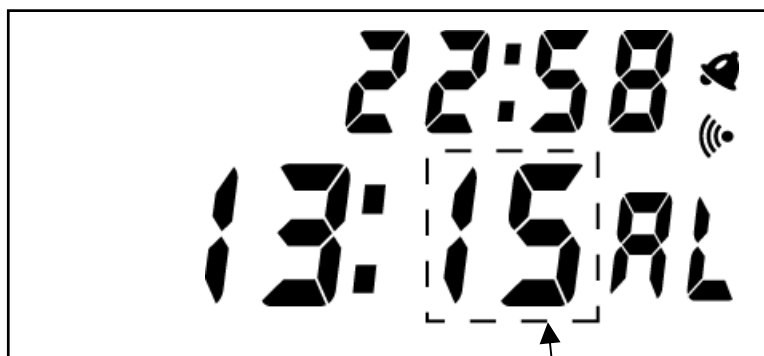

Flashing at 1Hz

- Press [ST/STP] to select desired digits for adjustment. Digits will be selected with the following order:

Minute -> Hour -> Minute
- Press [LAP/RESET] to adjust the selected digit. Procedures same as Real Time Clock Setting.
- Press [MODE] once to exit setting and return to Daily Alarm.



愛高實業(香港)有限公司 HICO INDUSTRIAL (HK) LIMITED

22/F., DELTA HOUSE, 3 ON YIU STREET, SIU LEK YUEN, SHATIN, N.T., HONG KONG.
TEL: (852) 2648 6862 FAX: (852) 2637 3691 URL: <http://www.hico.com.hk> EMAIL: enquiry@hico.com.hk
香港新界沙田小瀝源安耀街三號匯達大廈二十二樓

10-Lap Sport Watch (HCS-T005-0)

9. Schedule Alarm

- Display format

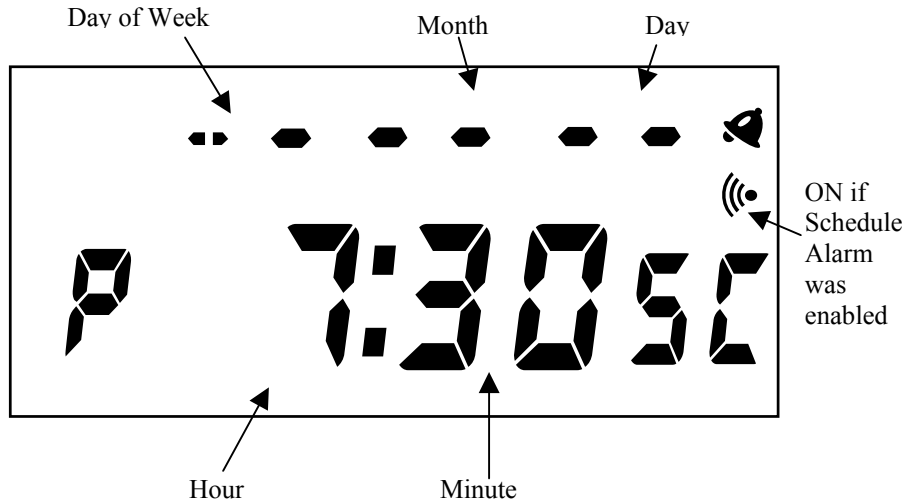

- Press [LAP/RESET] to enable/disable Schedule Alarm.
- Press and hold [ST/STP] to hear alert signal from the buzzer.
- Press and release [MODE] within 2 seconds to change to Real Time Clock.
- Press and hold [MODE] for more than 2 seconds to activate Schedule Alarm Setting.
- Display format for Schedule Alarm Setting:

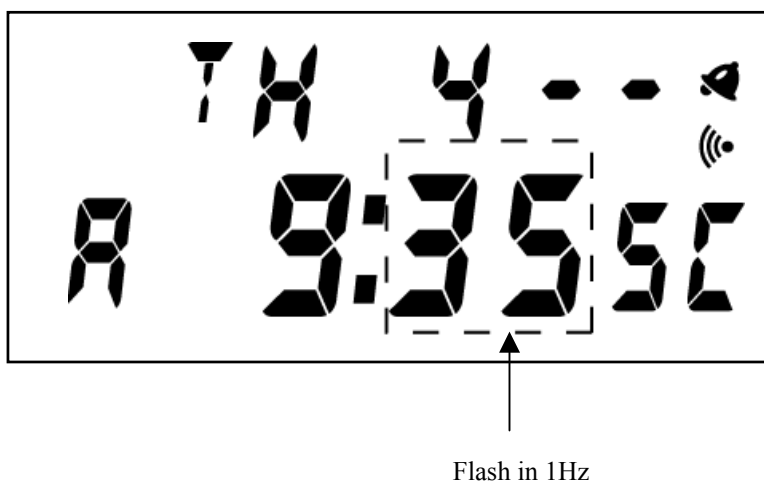

- Press [ST/STP] to select digit to be altered. Selection sequence is as follows:
Minute -> Hour -> Month -> Day -> Day of Week -> Minute
- Press [LAP/RESET] to alter the selected digit.



愛高實業(香港)有限公司

HICO INDUSTRIAL (HK) LIMITED

22/F., DELTA HOUSE, 3 ON YIU STREET, SIU LEK YUEN, SHATIN, N.T., HONG KONG.

TEL: (852) 2648 6862 FAX: (852) 2637 3691 URL: <http://www.hico.com.hk> EMAIL: enquiry@hico.com.hk

香港新界沙田小瀝源安耀街三號匯達大廈二十二樓

10-Lap Sport Watch (HCS-T005-0)

- Press [MODE] once will exit setting and return to Schedule Alarm.
- Adjustable range for the digits are:
 - Minute: 0 to 59
 - Hour: A 12 to P 11 (in 12-hour display)
0 to 23 (in 24-hour display)
 - Month: 1 to 12
 - Day: 1 to 31 (for Month = 1, 3, 5, 7, 8, 10, 12)
1 to 30 (for Month = 4, 6, 9, 11)
1 to 29 (for Month = 2)
 - Day of Week: SU → SA
- The checking on Month, Day, & Day of Week can be disabled by setting the corresponding digit to show ‘-’ . With the suitable setting, the Schedule Alarm can be operated to alert daily, weekly, monthly, and etc. Here listed some examples:
 - Daily alarm: ‘- - - - -’
 - Weekly on Thursday: ‘TH - - - -’
 - Monthly on Day=11: ‘- - - - 1 1’
 - All days in April: ‘- - 4 - -’
- Schedule Alarm will not be operated under:
 - Real Time Clock Setting
 - Schedule Alarm Setting
- Alert signal (different from that of Daily Alarm) will be played for 20 seconds upon reaching the preset schedule. Press any key will stop the alert signal.
- If both Schedule Alarm & Daily Alarm alerted at the same time, the Schedule Alarm will have the highest priority that only the Schedule Alarm alert signal will be heard from the buzzer.



愛高實業(香港)有限公司 HICO INDUSTRIAL (HK) LIMITED

22/F., DELTA HOUSE, 3 ON YIU STREET, SIU LEK YUEN, SHATIN, N.T., HONG KONG.

TEL: (852) 2648 6862 FAX: (852) 2637 3691 URL: <http://www.hico.com.hk> EMAIL: enquiry@hico.com.hk

香港新界沙田小瀝源安耀街三號匯達大廈二十二樓

10-Lap Sport Watch (HCS-T005-0)

10. Pacer Beat

- Operation flow

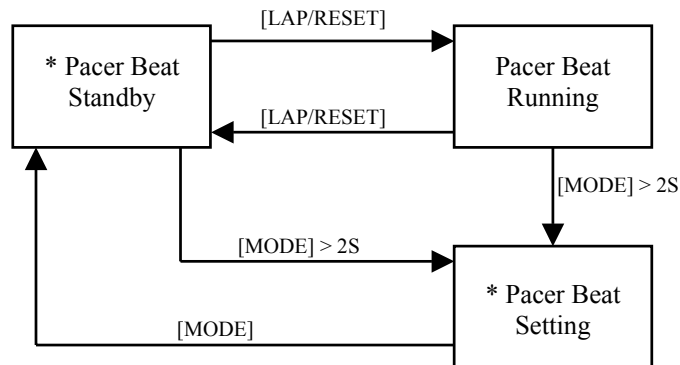

* Will have Auto Return Function

- Display format

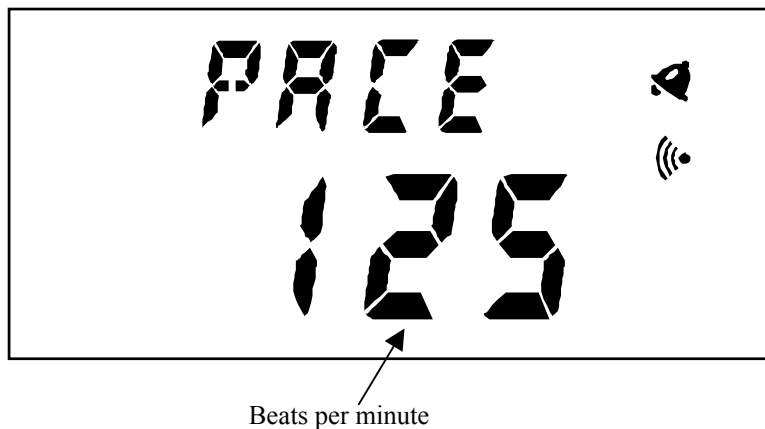

- Default beat rate is 65 beats per minute.
- Press [LAP/RESET] to start/stop Pacer Beat. If started, beep sound will heard from the buzzer according to the beat rate set.
- Beep sound will be generated only with the following conditions:
 - In Pacer Beat
 - In Chronograph while counting was started
- Press and release [MODE] within 2 seconds to change to Chronograph.
- Press and hold [MODE] for more than 2 seconds to adjust the beat rate.



愛高實業(香港)有限公司
HICO INDUSTRIAL (HK) LIMITED

22/F., DELTA HOUSE, 3 ON YIU STREET, SIU LEK YUEN, SHATIN, N.T., HONG KONG.
 TEL: (852) 2648 6862 FAX: (852) 2637 3691 URL: <http://www.hico.com.hk> EMAIL: enquiry@hico.com.hk
 香港新界沙田小瀝源安耀街三號匯達大廈二十二樓

10-Lap Sport Watch (HCS-T005-0)

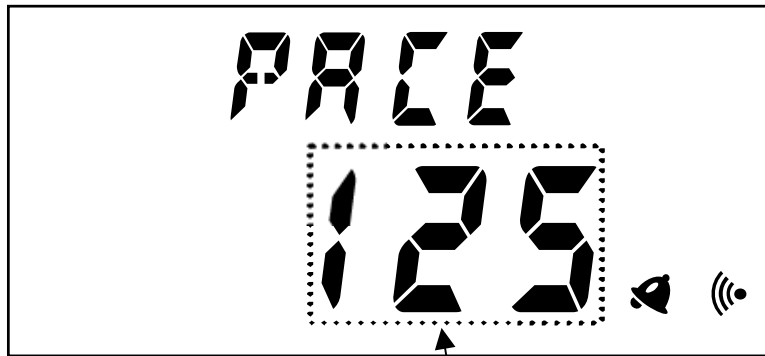

Flashing at 1Hz

- Pacer Beat will be stopped upon enter into Pacer Beat Setting.
- Press [LAP/RESET] to adjust the beat rate per minute from 65 to 180 with 5 beats per step.
- Press [MODE] once will exit setting and return to Pacer Beat.

11. Chronograph Mode

- Operation flow

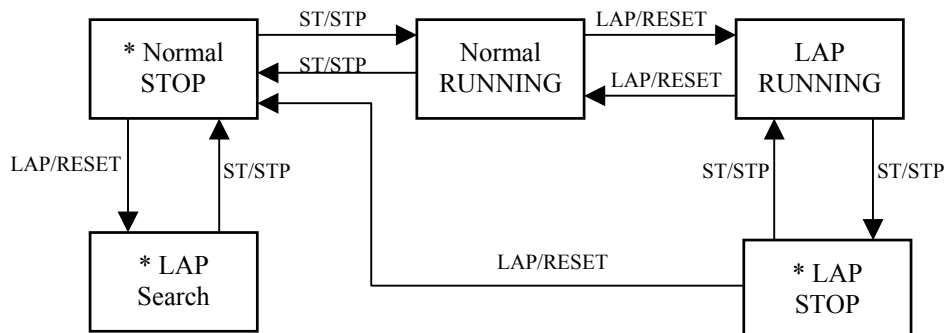

* Will have Auto Return Function



愛高實業(香港)有限公司 HICO INDUSTRIAL (HK) LIMITED

22/F., DELTA HOUSE, 3 ON YIU STREET, SIU LEK YUEN, SHATIN, N.T., HONG KONG.

TEL: (852) 2648 6862 FAX: (852) 2637 3691 URL: <http://www.hico.com.hk> EMAIL: enquiry@hico.com.hk

香港新界沙田小瀝源安耀街三號匯達大廈二十二樓

10-Lap Sport Watch (HCS-T005-0)

- Display format (Normal State)

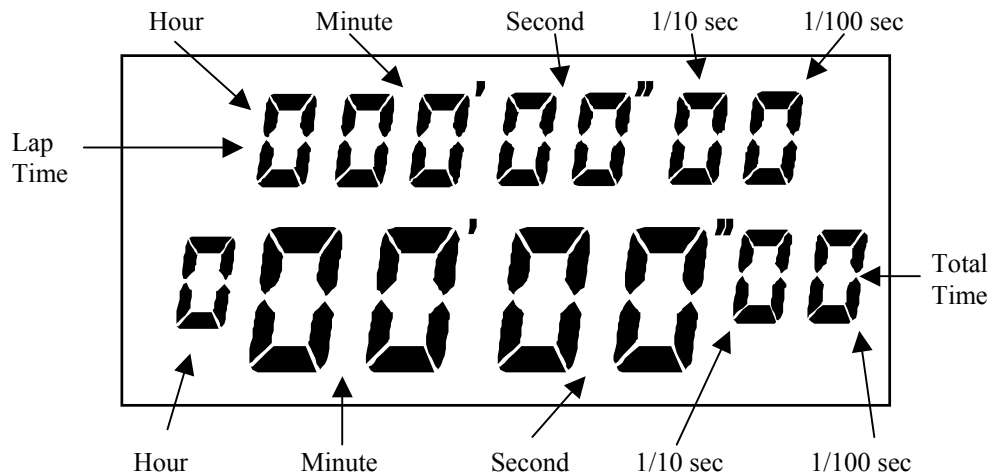

- Display format (LAP Time)

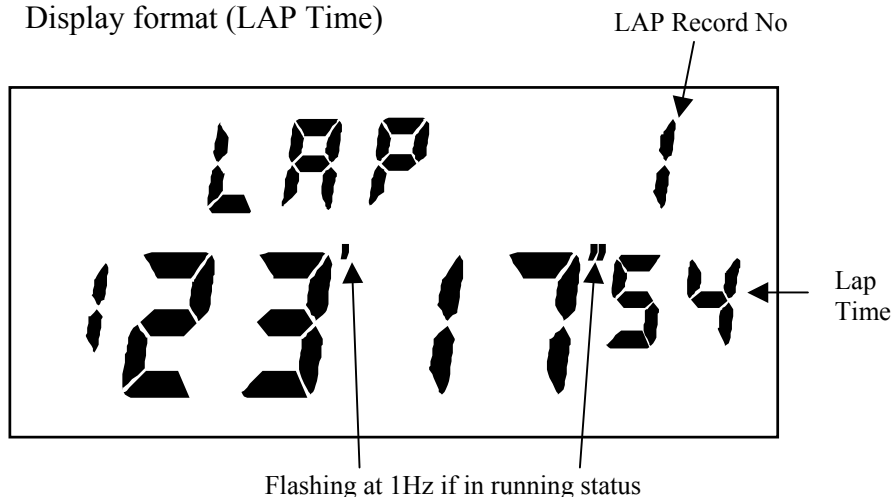

- Press [MODE] once to change to Timer 1.
- Press [ST/STP] to start/stop chronograph.
- Press [LAP/RESET] while chronograph was stopped will activate lap time search. Lap memories can be recalled one by one by pressing the key repeatedly.
- Press and hold [LAP/RESET] key for more than 2 seconds while chronograph was stopped (not in LAP RECALL) will reset the chronograph counters to zero.
- Press [LAP/RESET] while chronograph was started to save the current lap time to lap memory. Up to 10 memories can be saved. Lap Timer will be reset and restart counting except the last lap.



愛高實業(香港)有限公司
HICO INDUSTRIAL (HK) LIMITED

22/F., DELTA HOUSE, 3 ON YIU STREET, SIU LEK YUEN, SHATIN, N.T., HONG KONG.
 TEL: (852) 2648 6862 FAX: (852) 2637 3691 URL: <http://www.hico.com.hk> EMAIL: enquiry@hico.com.hk
 香港新界沙田小瀝源安耀街三號匯達大廈二十二樓

10-Lap Sport Watch (HCS-T005-0)

- Maximum count will be 9 hours 59 minutes 59.99 seconds. Counting will be restarted from zero upon maximum count is reached.
- If Pacer Beat is started, alert sound will be heard while the chronograph is in running state.

12. Count Down Timer

- Operation flow

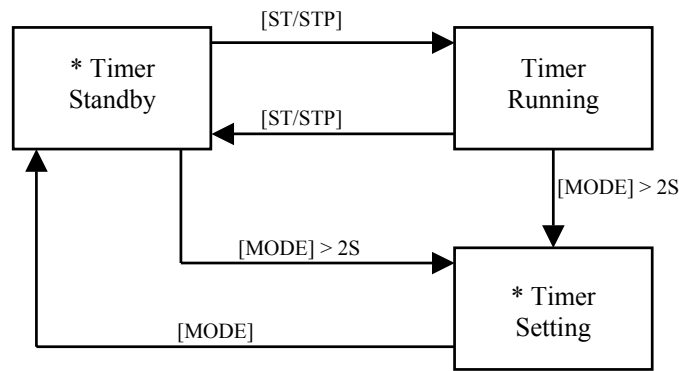

* Will have Auto Return function

- Display format

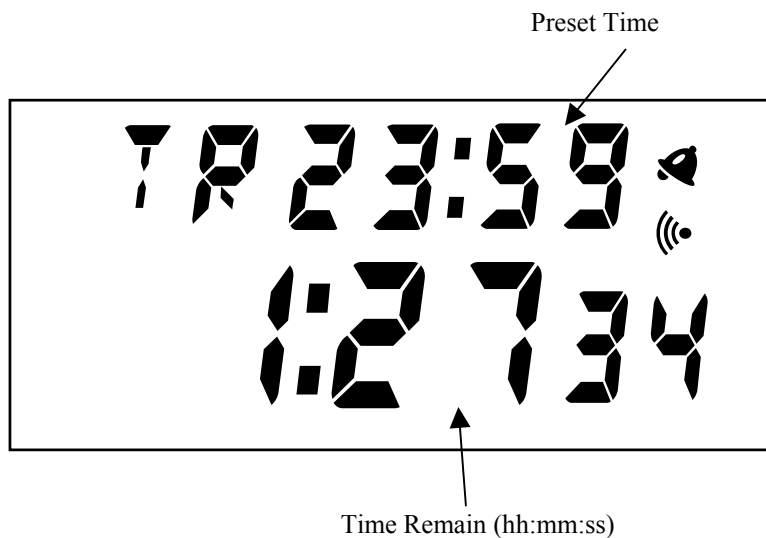

- Press and release [MODE] within 2 seconds will change to Dual Time.
- Press [ST/STP] to start/stop the Timer.



愛高實業(香港)有限公司 HICO INDUSTRIAL (HK) LIMITED

22/F., DELTA HOUSE, 3 ON YIU STREET, SIU LEK YUEN, SHATIN, N.T., HONG KONG.

TEL: (852) 2648 6862 FAX: (852) 2637 3691 URL: <http://www.hico.com.hk> EMAIL: enquiry@hico.com.hk

香港新界沙田小瀝源安耀街三號匯達大廈二十二樓

10-Lap Sport Watch (HCS-T005-0)

- While Timer stopped, press [LAP/RESET] to reload the preset value.
- Press and hold [MODE] for more than 2 seconds to activate timer setting. Upon entering setting state, the Timer will stop counting with the Minute digit in Preset Time flashing at 1Hz.
- Press [ST/STP] to select the digits to be altered:
Minute -> Hour -> Minute
- Press [LAP/RESET] to set the selected digits.
- Press [MODE] to confirm the setting.

13. Dual Time

- Display format:

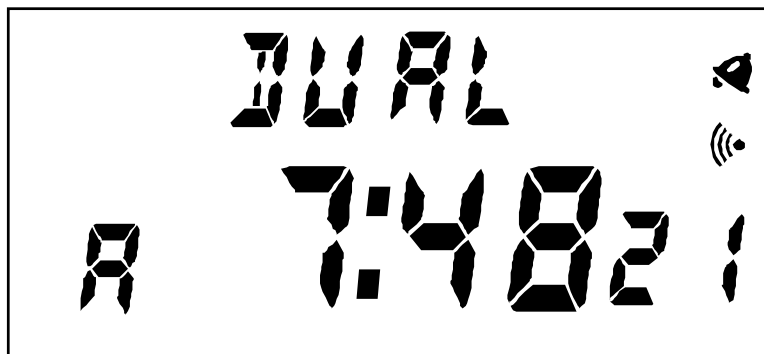

- Press and release [MODE] within 2 seconds to change to Schedule Alarm.
- Press and hold [MODE] for more than 2 seconds to activate Dual Time Setting. Upon entering setting state, Minute digit will be flashed at 1Hz.
- Use [ST/STP] to select between Hour & Minute for adjustment.
- Use [LAP/RESET] to adjust the selected digits and press [MODE] once to exit.
- Second will be synchronized with Real Time Clock.
- Auto return to Real Time Clock will only be activated in Dual Time Setting if no key operation for 1 minute.

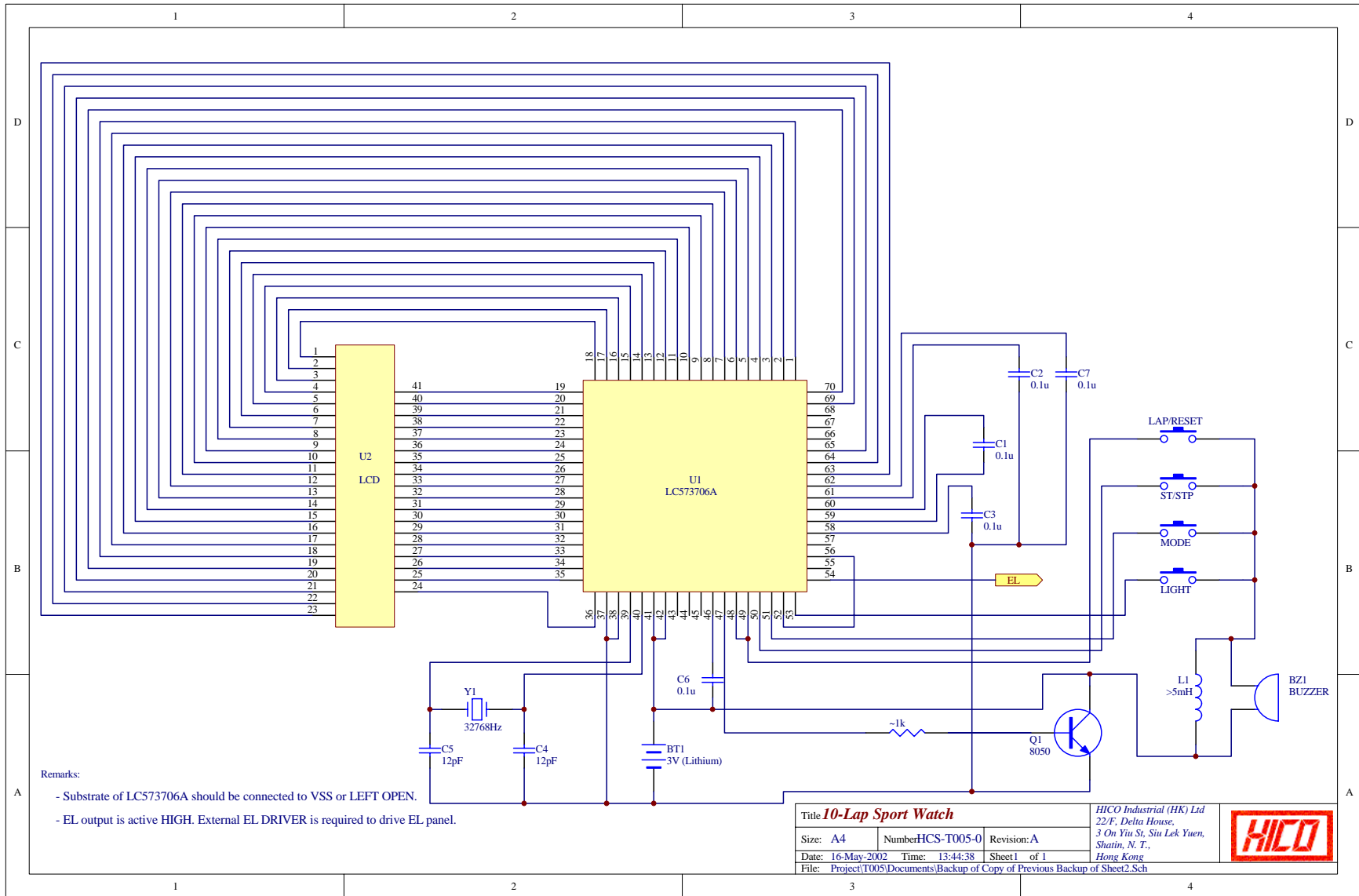

Remarks:

- Substrate of LC573706A should be connected to VSS or LEFT OPEN.
- EL output is active HIGH. External EL DRIVER is required to drive EL panel.

Title 10-Lap Sport Watch			HICO Industrial (HK) Ltd 22/F, Delta House, 3 On Yiu St, Siu Lek Yuen, Shatin, N. T., Hong Kong
Size: A4	Number: HCS-T005-0	Revision: A	
Date: 16-May-2002	Time: 13:44:38	Sheet 1 of 1	
File: Project\T005\Documents\Backup of Copy of Previous Backup of Sheet2.Sch			
			

VER NO.	DISPLAY TYPE	DRIVE CONDITION	DISPLAY MODE	OPERATION TEMPERATURE	STORAGE TEMPERATURE	OPERATION VOLTAGE	VIEWING DIRECTION	REMARK
00	TN GLASS	1/3 DUTY 1/3 BIAS	TRANSFLECTIVE POSITIVE	-10°C TO +60°C	-20°C TO +70°C	4.5 V	6 : 00	FRONT POL. : F1205DU REAR POL. : G4225NP3

HICO INDUSTRIAL CO.

Description	General Specification		
Model no.	CL14016E		
DWG no.	4545	Rev.no.	A01
Scale		Unit	mm
Page	1	of	5
Date	13-06-2001		
Drawn by	B1-HONG		
Checked by			

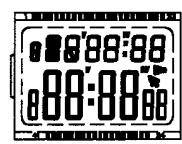
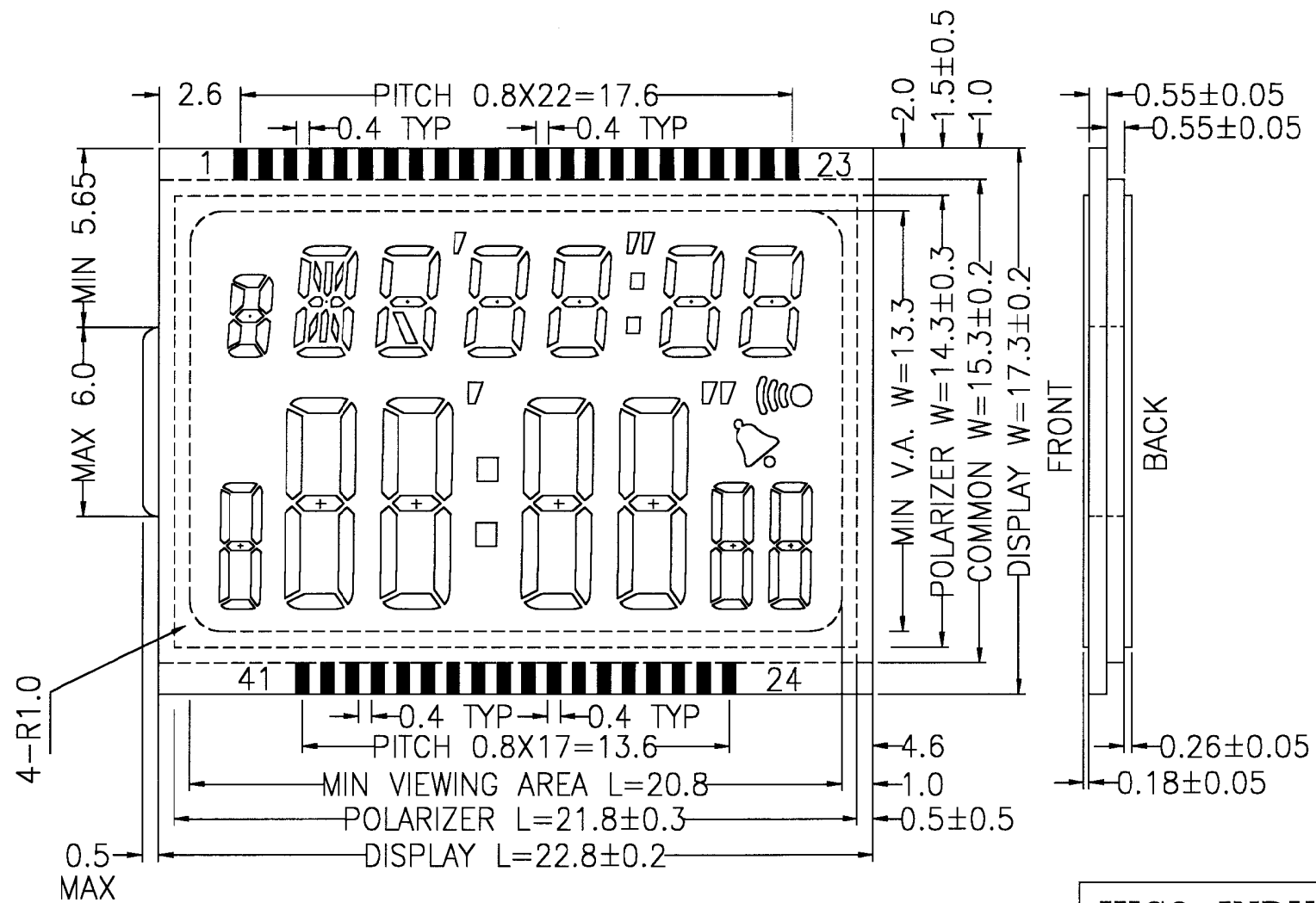
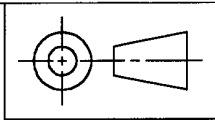

(1 : 1)

HICO INDUSTRIAL CO.

Description	LCD ARTWORK		
Model no.	CL14016E		
DWG no.	4545	Rev.no.	A01
Scale	5 : 1	Unit	
Page	2	of	5
Date	13-06-2001		
Drawn by	B1-HONG		
Checked by			

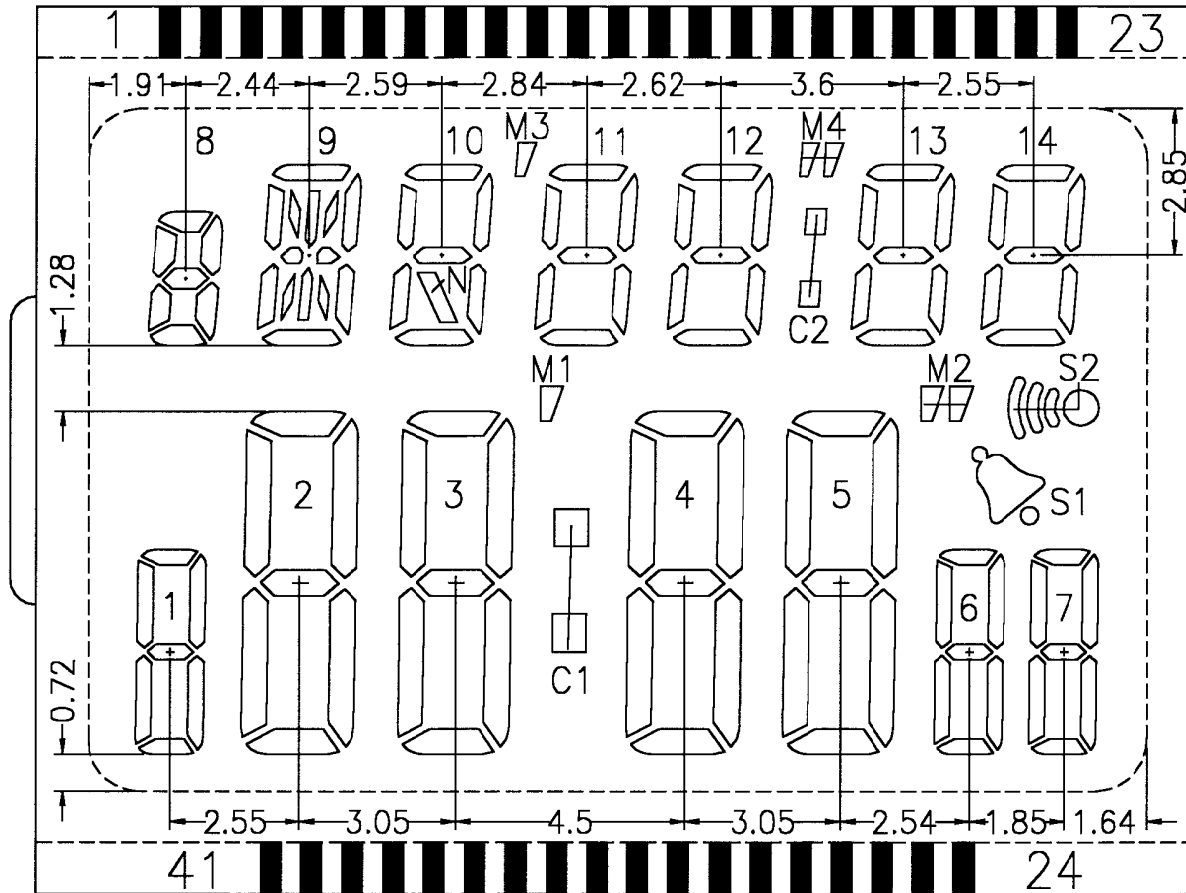
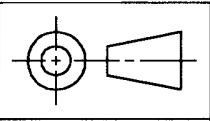

HICO INDUSTRIAL CO.			
Description	Labelling		
Model no.	CL14016E		
DWG no.	4545	Rev.no.	A01
Scale	7 : 1	Unit	
Page	3	of	5
Date	13-06-2001		
Drawn by	B1-HONG		
Checked by			

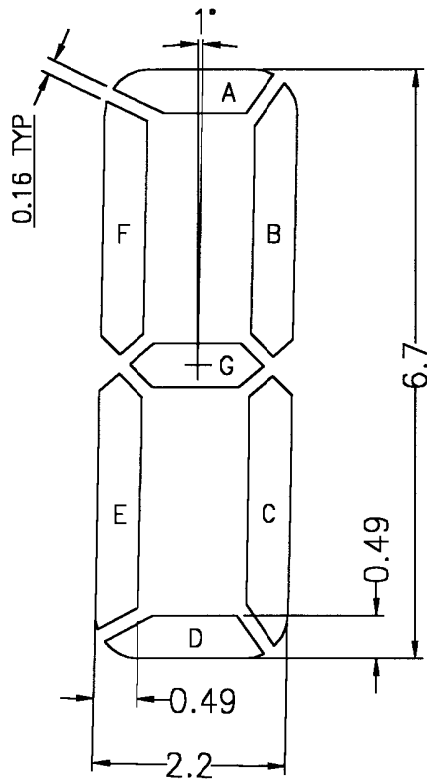
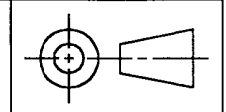

(DIGIT:2-5)

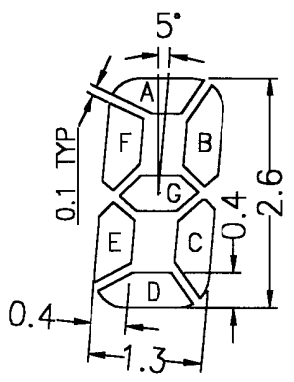

(DIGIT:8)

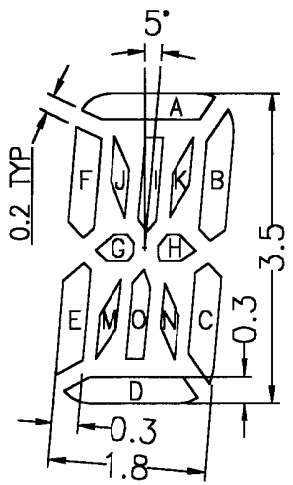

(DIGIT:9)

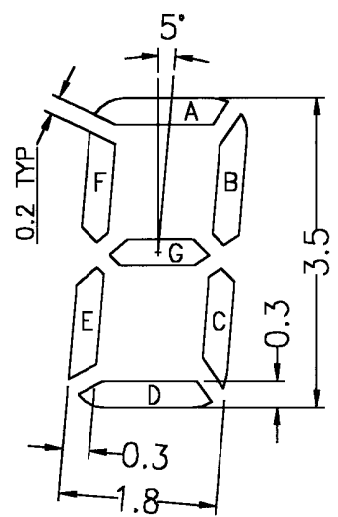

(DIGIT:10-14)

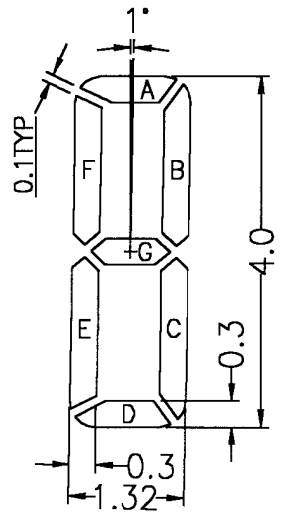

(DIGIT:1,6,7)

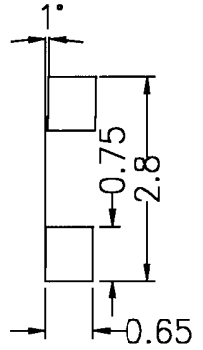

(DIGIT:C1)
(10 : 1)

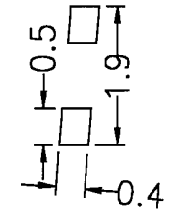

(DIGIT:C2)
(10 : 1)

HICO INDUSTRIAL CO.			
Description	Graphic Dimension		
Model no.	CL14016E		
DWG no.	4545	Rev.no.	A01
Scale	12 : 1	Unit	
Page	4	of	5
Date	13-06-2001		
Drawn by	B1-HONG		
Checked by			

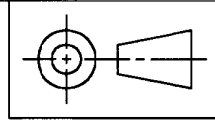

<u>PAD NO.</u>	<u>IC NO.</u>	<u>COM1</u>	<u>COM2</u>	<u>COM3</u>	<u>PAD NO.</u>	<u>IC NO.</u>	<u>COM1</u>	<u>COM2</u>	<u>COM3</u>
1	S19	8D	8E	8F	32	S9	4A	4G	4D
2	S20	8C	8G	8A	33	S10	4F	C1	4E
3	S21	9E	9F	8B	34	S11	M1	3C	3D
4	S22	9M	9G	9J	35	S12	3B	3G	3E
5	S23	9O	9I	9A	36	S13	3A	3F	2C
6	S24	9N	9H	9K	37	S14	2B	2G	2D
7	S25	9D	9C	9B	38	S15	2A	2F	2E
8	S26	10D	10E	10F	39	S16	1A	1B	S1
9	S27	10N	10G	10A	40	S17	1G	1C	1D
10	S28	10C	10B	M3	41	S18	1F	1E	S2
11	S29	11E	11F	11A					
12	S30	11D	11G	11B					
13	S31	11C	12E	12F					
14	S32	12D	12G	12A					
15	S33	12C	12B	M4					
16	S34	13E	C2	13F					
17	S35	13D	13G	13A					
18	S36	14E	13C	13B					
19	S37	14D	14G	14F					
20	S38	14C	14B	14A					
21	COM3	--	--	COM3					
22	COM2	--	COM2	--					
23	COM1	COM1	--	--					
24	S1	7B	7A	7C					
25	S2	7G	7F	7D					
26	S3	6B	6A	7E					
27	S4	6G	6F	6C					
28	S5	6D	6E	M2					
29	S6	5B	5C	5D					
30	S7	5A	5G	5E					
31	S8	5F	4B	4C					

HICO INDUSTRIAL CO.			
Description	Pad Configuration		
Model no.	CL14016E		
DWG no.	4545	Rev.no.	A01
Scale		Unit	
Page	5	of	5
Date	13-06-2001		
Drawn by	B1-HONG		
Checked by			

+ send pad assignment to you.

1-4 Pad assignment

Fusejima

Chip thickness : 480μm
 Pad size : 100μm × 100μm

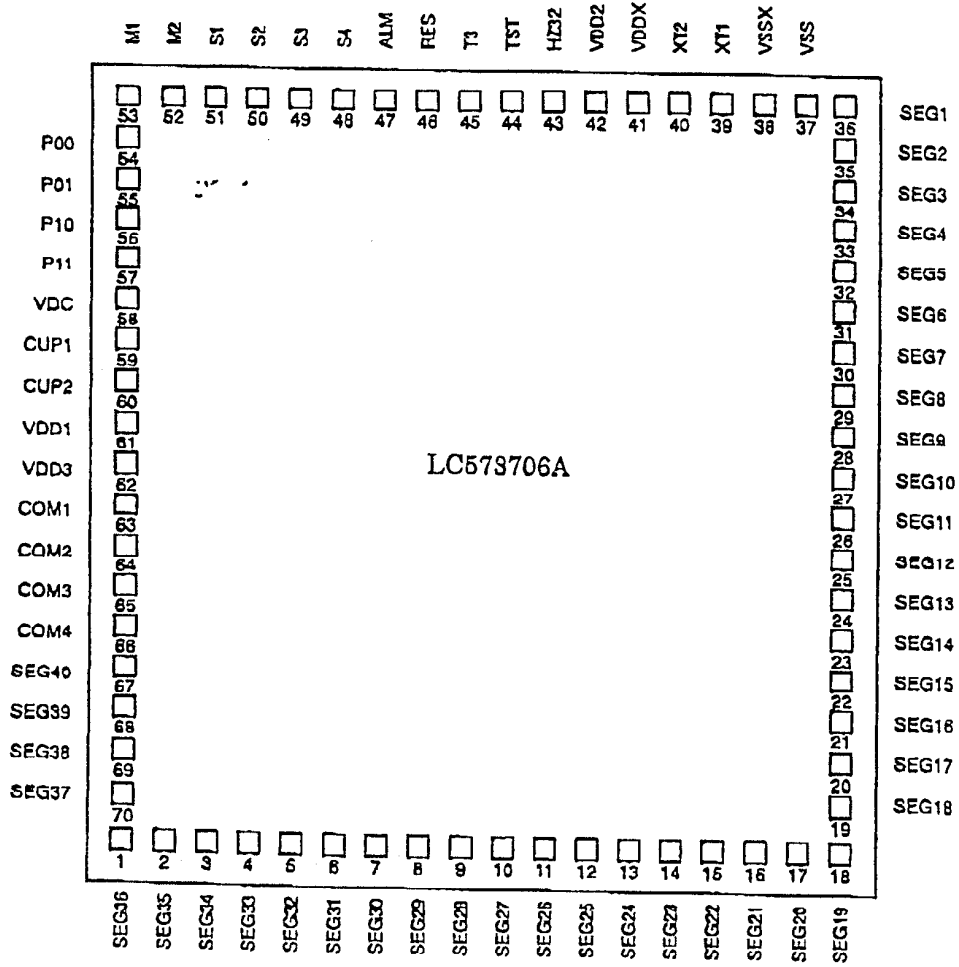

Fusejima

LC573706A__Pin Name and Coordinates

July 19, 2000

PIN No.	PIN NAME	Coordinates	
		"X" μ m	"Y" μ m
1	SEG36	-1081	-1365
2	SEG35	-961	-1365
3	SEG34	-841	-1365
4	SEG33	-721	-1365
5	SEG32	-601	-1365
6	SEG31	-481	-1365
7	SEG30	-361	-1365
8	SEG29	-241	-1365
9	SEG28	-121	-1365
10	SEG27	-1	-1365
11	SEG26	119	-1365
12	SEG25	239	-1365
13	SEG24	359	-1365
14	SEG23	479	-1365
15	SEG22	599	-1365
16	SEG21	719	-1365
17	SEG20	839	-1365
18	SEG19	959	-1365
19	SEG18	1222	-1141
20	SEG17	1222	-1021
21	SEG16	1222	-901
22	SEG15	1222	-781
23	SEG14	1222	-661
24	SEG13	1222	-541
25	SEG12	1222	-421
26	SEG11	1222	-301
27	SEG10	1222	-181
28	SEG09	1222	-61
29	SEG08	1222	59
30	SEG07	1222	179
31	SEG06	1222	299
32	SEG05	1222	419
33	SEG04	1222	539
34	SEG03	1222	659
35	SEG02	1222	779
36	SEG01	1222	899
37	VSS	1259	1365
38	VSSX	1119	1365
39	XT1	999	1365
40	XT2	879	1365

PIN No.	PIN NAME	Coordinates	
		"X" μ m	"Y" μ m
41	VDDX	759	1365
42	VDD2	579	1365
43	HZ32	459	1365
44	TEST	339	1365
45	T3	219	1365
46	RES	-51	1365
47	ALM	-321	1365
48	S4	-441	1365
49	S3	-561	1365
50	S2	-681	1365
51	S1	-801	1365
52	M2	-921	1365
53	M1	-1041	1365
54	P00	-1222	1037
55	P01	-1222	917
56	P10	-1222	797
57	P11	-1222	677
58	VDC	-1222	527
59	CUP1	-1222	377
60	CUP2	-1222	257
61	VDD1	-1222	107
62	VDD3	-1222	-49
63	COM1	-1222	-202
64	COM2	-1222	-323
65	COM3	-1222	-442
66	COM4	-1222	-562
67	SEG40	-1222	-682
68	SEG39	-1222	-802
69	SEG38	-1222	-922
70	SEG37	-1222	-1042
71			
72			
73			
74			
75			
76			
77			
78			
79			
80			

CHIP SIZE = 2.89 x 3.17